

**Attachment by screw**  
(When double-sided tape does not stick or for a sliding door)

Fix by screws at four points.

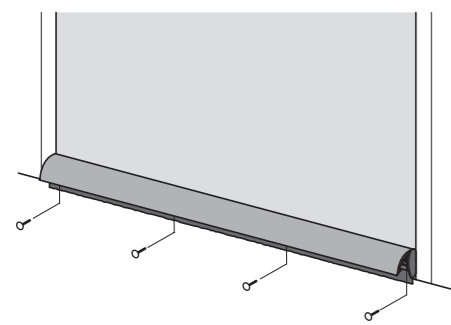

■Mounting points

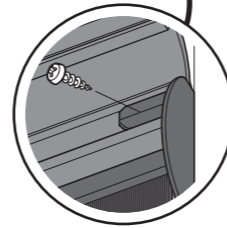
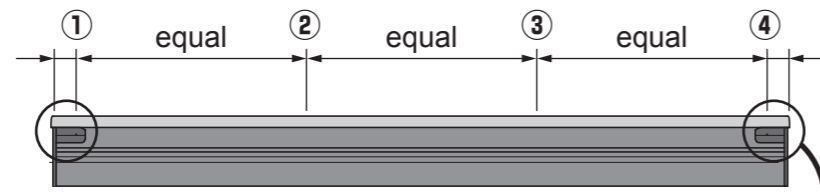

Fix each cap

**Post-installation check**

- Check that the door can open and close.
- Check that the holder is not loose.
- Check that the brush is set in the holder.

**Regular maintenance/check items**

- Do not use in an ambient temperature in excess of -10°C / 14°F — 60°C / 140°F.
- Rodents with heads smaller than the bristle height may be able to pass through.
- In the event of deformation or other product malfunction, cease use and replace immediately.
- Check that the double-sided tape is attaching the holder to the door and fix with screws in the case the holder is becoming detached.
- Check that the holder or brush is not misaligned. Injuries may be caused if either is misaligned.
- Remove any particles caught in the brush. (Approximately once per month)

**Instruction manual**  
**Burrat Samurai Armor Door Sweep**

Stock number : 23506500(BRSA-1000-7)  
23506600(BRSA-1000-12)



Thank you very much for purchasing the Burrat Samurai Armor Door Sweep.

- This product is only for use on doors. Please do not use it for other purposes.
- Please read this instruction manual carefully and install the product correctly and safely. **In particular, make sure to read the Safety Precautions before installation.**
- Burrtec is not responsible for accidents or damages due to installation by methods not described in this instruction manual or by not using the designated parts. Product faults caused by such installation methods are not covered by guarantee.
- Please dispose of packaging etc. in accordance with your local laws.

**Safety Precautions** Please observe

○Make sure to observe these instructions to prevent injury or damage to property.

- This explains the degree of danger or damage that can arise through mistaken installation.
- The precautions you should observe are indicated by the following symbols.

**! WARNING** Danger of light injury or damage to property.

**! Item that must be carried out.**

**! WARNING**

<p><b>! Be sure to observe.</b></p>	<p>•<b>Make everyone aware of work in progress</b> Sudden opening of the door could injure a worker.</p>	<p><b>! Be sure to observe.</b></p>	<p>•<b>Be careful when cutting the holder because the reverse side is slippery</b> The metal saw may cause injuries to hands.</p>
	<p>•<b>Always use protective gloves</b> The edge of the holder etc. may cause injuries.</p>		<p>•<b>Check that the brush is mounted properly</b> Injuries may be caused if the brush detaches.</p>
	<p>•<b>Take care when drilling holes</b> Danger of injury.</p>		<p>•<b>Check that the holder is firmly fixed in place</b> Injuries may be caused if the holder detaches.</p>

## Components

Component name	Burrat Samurai Armor Door Sweep	Caps	Instruction manual
Illustration			
Contents	1	2	1
Remarks			

## Necessary tools

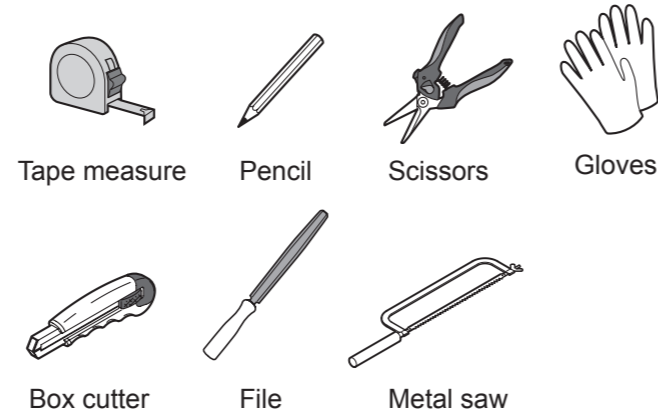

**⚠ WARNING**

**Always use protective gloves**  
The edge of the holder etc. can cause injuries.

Be sure to observe.

## Mounting conditions

- Cut to the same width as the door and mount.

Cutting to the same width as the door may prevent some doors from opening and closing. Check the door can open and close and cut to suit the location of use.

- Mount on the side from which rodents enter.
- The door must be level with the floor.  
The door may not be able to open and close if the door is not level with the floor.
- Fix with screws if holder does not attach with double-sided tape or in the case of a sliding door.

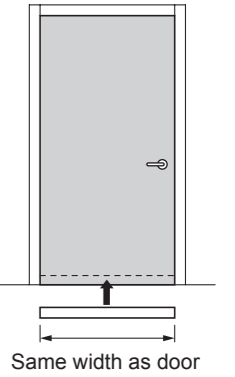

## Installation procedure

### 1 Remove brush

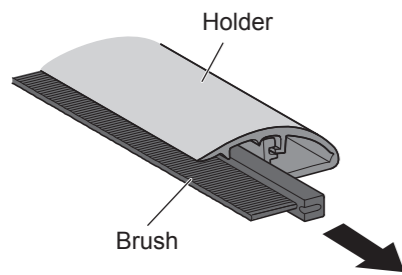

### 2 Measure the length to cut

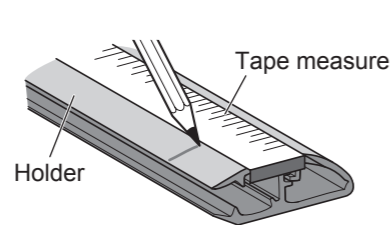

Mark the position of the cut on the holder according to the length of the door.

### 3 Cut the holder

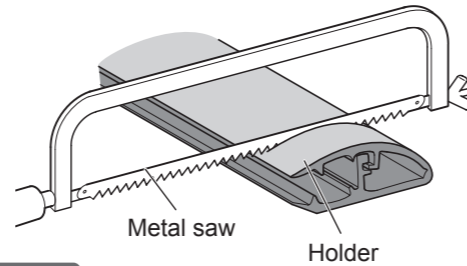

**Please**

- The holder can slip, so cut slowly.**  
When cutting quickly the saw may slip and scratch the holder.
- Cut perpendicularly.**  
If the cut is not perpendicular, there may be a gap when the cap is attached.

### 4 File the cut surface

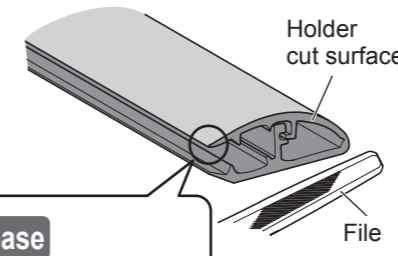

**Please**

**Take care. Sharp edges can form on the stainless steel.**

Remove burrs on the holder cut surface with a file.

### 5 Insert the brush

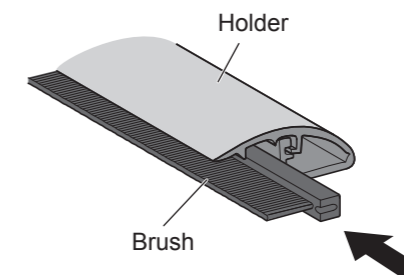

### 6 Cut the brush

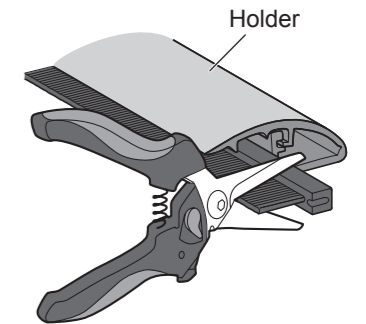

Cut the brush to fit the length of the holder.



### 7 Attach the brush and the caps

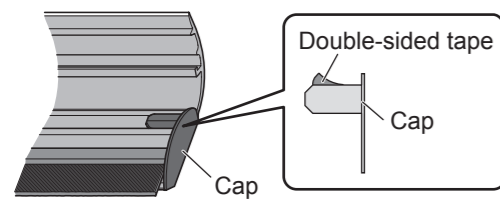

Open the holder, and clean it. Attach caps with double sided tap. Then close the holder.

#### Tips

##### How to open

Insert fingers between the holder and brush from the **side with the double-sided tape** and prize open

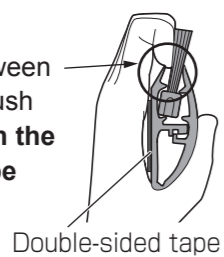

### 8 Provisionally attach to the door

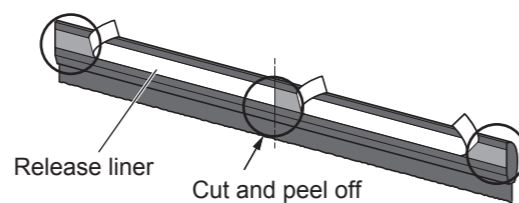

Cut off the release liner of the double-sided tape in one place and provisionally attach to the door.

- \*Remove grease or dust etc. from the surface.
- \*Door paint may peel off when adjusting the double-sided tape.

### 9 Check door opens and closes



- Check the door can open and close.
- \*Adjust the position of the holder if the door cannot open and close.

### 10 Affix to door

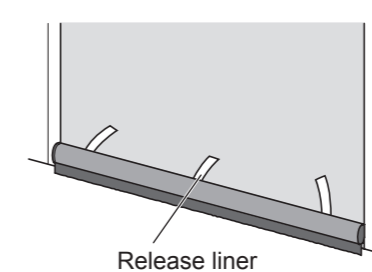

Remove the release liner of the double-sided tape and fix the holder to the door.

### 11 Remove protective sheet

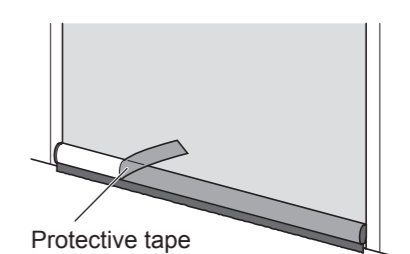

#### Installation complete

Proceed to "Post-installation check" check on the reverse.

**In the case double-sided tape does not fix the holder or for a sliding door, proceed to "Attachment by screw" on the reverse.**